

MAX. PAYLOAD: 2.4 tonnes (5291lb) MAX. LIFT HEIGHT: 5.3 metres (17ft 4in) MAX. HORSEPOWER: 63 kW (85hp)

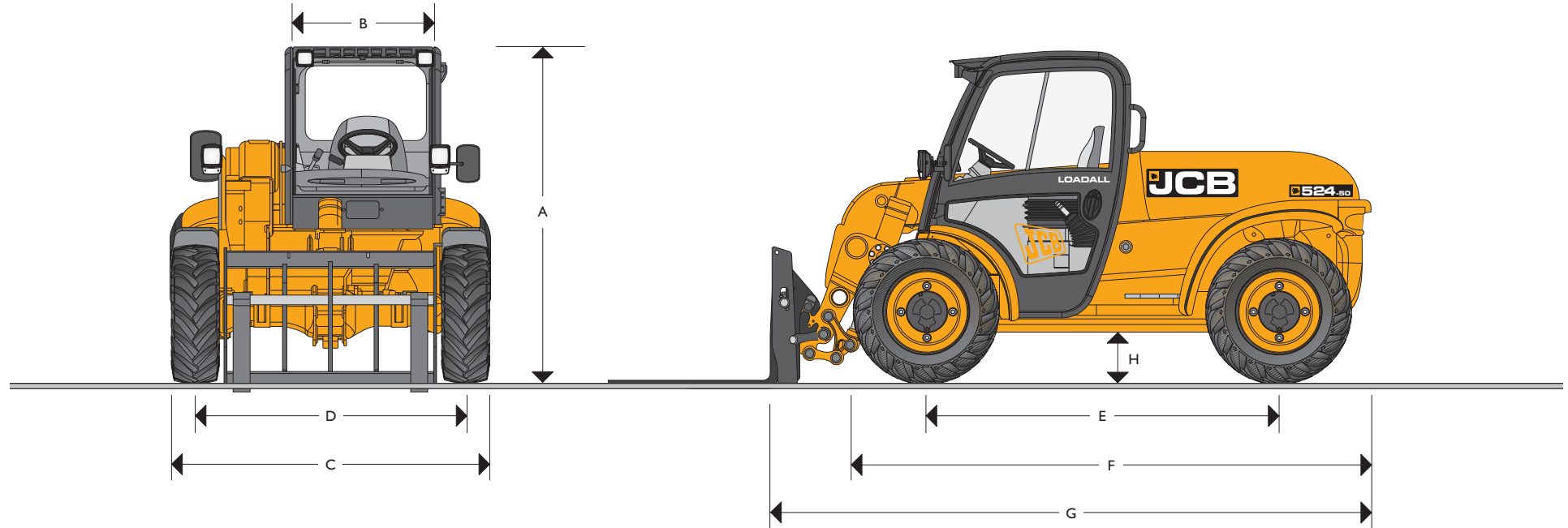

STATIC DIMENSIONS

Machine model	524-50
	m (ft-in)
A Overall height	2.1 (6-11)
B Inside width of cab	0.92 (3-0)
C Width over tyres (min)	2.0 (6-7)
D Front track	1.7 (5-7)
E Wheel base	2.3 (7-6)
F Overall length to front of tyres	3.4 (11-2)

Machine model	524-50
	m (ft-in)
G Overall length to front of carriage	3.9 (12-10)
H Ground clearance	0.33 (1-1)
Outer turn radius over tyres	3.0 (9-10)
Weight	5500 (12125)
Tyres	12.5/80 x 18

LIFT PERFORMANCE – 524-50

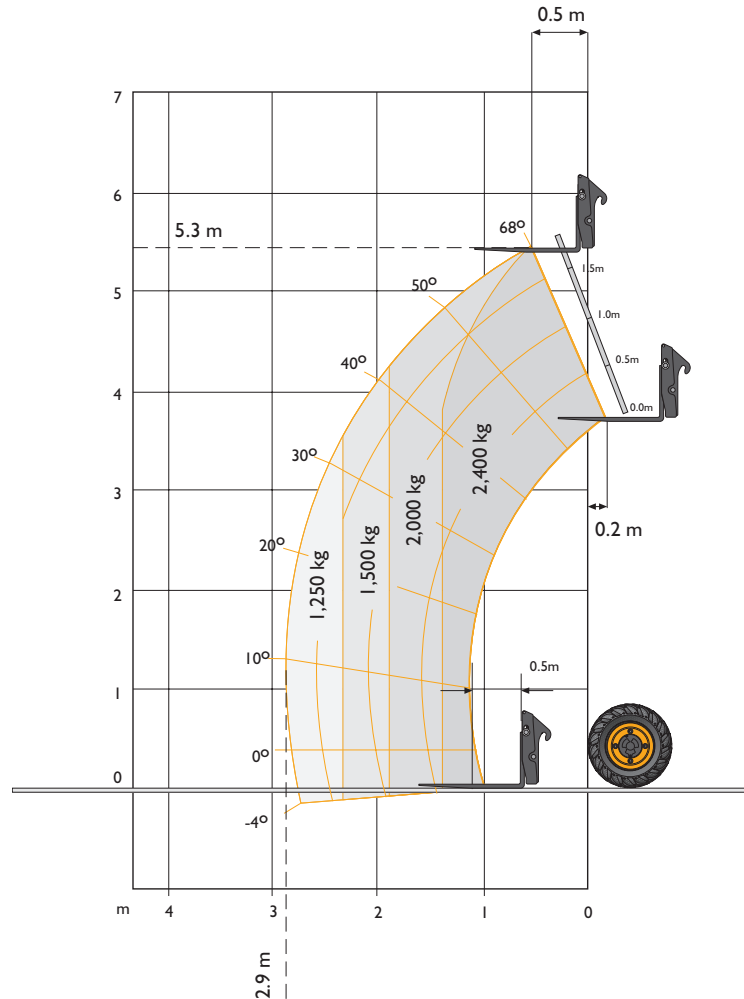

LIFT PERFORMANCE

Machine Model		Compact Tool Carrier
		524-50
Lift capacity at full height	kg (lb)	2400 (5291)
Lift capacity at full reach	kg (lb)	1250 (2756)
Max. lift height	m (ft-in)	5.3 (17-4)
Reach at max. lift height	m (ft-in)	0.6 (2-0)
Maximum reach forward	m (ft-in)	2.9 (9-6)

LOADER PERFORMANCE

Machine Model		Compact Tool Carrier
		524-50
Shovel rated capacity	m ³	1.0
Breakout force	kN (kg)	40 (4079)
	kg (lb)	4079 (8993)
Dump height (max)	m (ft-in)	4.55 (14-11)
Dump angle at max height	degrees	45
Loadover height (max)	m (ft-in)	5.08 (16-8)
Rollback angle at ground	degrees	40
Carriage rotation angle (total)	degrees	150
Bucket width	m (ft-in)	2.08 (6-10)

ENGINE

		524-50
Model		JCB Diesel TC-63
Displacement	litres	4.4
Fuel		Diesel
Cooling		Liquid
Bore	mm	103
Stroke	mm	132
Gross power @ 2200 rpm		
ISO 14396	kW (hp)	63.0 (85)
Gross torque @ 1300 rpm		
ISO 14396	Nm (lb/ft)	362 (267)
Emission certification		EC Stage IIIA/USA EPA Tier 3
Engine oil service intervals		500 hours

TRANSMISSION & AXLES

Transmission: Travel speed – 29 km/h

Hydrostatic transmission. Automotive control closed loop variable displacement piston pump and variable displacement bent axis motor. Transmission inching facility on operation of a combined inching and braking pedal.

Axles: Front and rear drive axles: Epicyclic hub reduction type with mid mounted dropbox.

Rear axle oscillation.

Optional front and rear limited slip differential axles.

BRAKES

Service brake: Hydraulically activated, single disc caliper brake on the transmission output shaft.

Parking brake: Manually operated single disc caliper brake on the transmission output shaft.

BOOM AND CARRIAGE

Boom is manufactured from high tensile steel.

Low maintenance, hard wearing pads.

JCB Compact Tool Carrier with manual or hydraulic pin locking, accepts forkframe with integral pallet forks and wide range of attachments.

SERVICE CAPACITIES

	litres (UK gal)
Fuel tank	75 (16.5)
Hydraulic tank	70 (15.4)
Coolant	14 (3.7)

ELECTRICS

12 V negative earth, 92 AH heavy duty battery with isolator. 95 amp alternator. Full road lighting, direction indicators, hazard warning.

HYDRAULICS

Single gear pump with suction strainer and filter. One boom and one auxiliary service fitted as standard.

Machine model	524-50	
Operating system pressure	bar (psi)	250 (3626)
Flow at system pressure (@ 2200rpm)	ltr/min	85
Cycle times	seconds	
Boom raise	7.7	
Boom lower	5.7	
Extend	5.5	
Retract	4.9	
Bucket dump	2.1	
Bucket crowd	3.0	

SAFETY CHECK VALVES

Fitted to the crowd, telescope and boom rams.

CAB

Quiet, safe and comfortable cab conforms to ROPS ISO3471 and FOPS ISO 3449. Tinted glass all round with laminated front and roof screen. Front and rear screen wash/wipe and heater/screen demister. Opening rear/door windows. Visual warning system for coolant temperature, engine oil pressure, air cleaner, battery charge, transmission oil pressure, engine temperature, fuel gauge and hourmeter.

Boom control lever incorporating forward/reverse switch. Throttle and brake pedals floor mounted. Adjustable deluxe suspension seat with side mounted park brake lever. Automatic eye level audio-visual load moment indicator warning system receiving a signal from a load sensor on the rear axle.

This system continuously monitors the machine's forward stability and leaves the operator in control at all times.

STEERING

Full power hydrostatic steering with three mode options: Front wheel steer, all wheel steer, crab steer all operated from a selection switch inside the cab.

Permanent four wheel drive with 52 degree steer angle front and rear provides exceptional manoeuvrability.

OPTIONS AND ACCESSORIES

Options: Work lights, rotating flashing beacon, fire extinguisher, limited slip diff front and rear axles, screen guard, sun blind, mechanical or hydraulic Compact tool carrier.

Attachments: Contact your local dealer for details of the comprehensive range.

A GLOBAL COMMITMENT TO QUALITY

JCB's total commitment to its products and customers has helped it grow from a one-man business into Britain's largest privately owned manufacturer of backhoe loaders, crawler excavators, wheeled excavators, telescopic handlers, wheeled loaders, dump trucks, rough terrain fork lifts, industrial fork lifts, mini/midi excavators, skid steer loaders, tractors and compaction equipment.

By making constant and massive investments in the latest production technology, the JCB factories have become some of the most advanced in the world.

By leading the field in innovative research and design, extensive testing and stringent quality control, JCB machines have become renowned all over the world for performance, value and reliability.

And with a global sales and service network of more than 650 dealers and agents, we aim to deliver the best customer support in the industry.

Through setting the standards by which others are judged, JCB has become one of the world's most impressive success stories.

